

# 632 031 Me 262 wheels

For Trumpeter kit - pro stavebnici Trumpeter



1/32 scale



R1



R2



R3

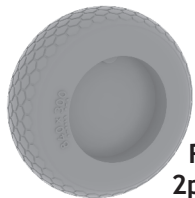
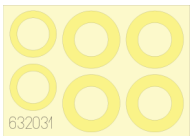

R4  
2pcs.



R5



R6



R7 2pcs.

## COLOURS

GSI Creos (GUNZE)			Mr.METAL COLOR	
AQUEOUS	Mr.COLOR			
<a href="#">H2</a>	<a href="#">C2</a>	BLACK		
<a href="#">H77</a>	<a href="#">C137</a>	TIRE BLACK		

This product contains metal and resin detail parts for upgrading scale plastic models. When selecting this set make sure that it is for the kit mentioned in product name as these sets are made specifically for that kit. When upgrading the model some cutting or corrections may be necessary for parts to fit accurately. **WARNING!** This set contains small and sharp parts. Work carefully in a ventilated and well-lit room. Safety glasses are recommended. This product is not suitable for children below 14 years of age.

Tento výrobek obsahuje leptané a odlévané detaily pro úpravu a vylepšení plastického modelu. Při výběru sady kovových detailů zkontrolujte, zda je určena pro model, který chcete upravit. Model, pro který je sada určena, je uveden u názvu výrobku. Pro přesnou aplikaci kovových a odlévaných dílů může být zapotřebí upravit díly upravovaného modelu. **POZOR!** Sada obsahuje malé ostré díly. Pracujte ve větrané a dobře osvětlené místnosti. Doporučujeme použití ochranných brýlí. Tento výrobek není vhodný pro děti mladší 14 let.



435 21 Obrnice 170  
Czech Republic



# 632 031 Me 262 wheels

For Trumpeter kit - pro stavebnici Trumpeter

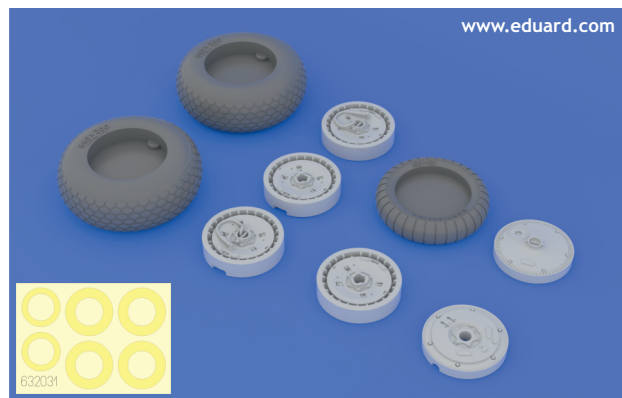

1/32



**BEST BRASS RESIN AROUND!**

 SYMMETRICAL ASSEMBLY  
SYMETRICKÁ MONTÁŽ

- |   |   |
|---|---|
|  REMOVE<br>ODSTRANIT        |  BEND<br>OHNOUT       |
|  GRIND<br>OBROUSIT         |  OPTION<br>VOLBA     |
|  DRILL HOLE<br>VRTAT OTVOR |  REPLACE<br>NAHRADIT |

*plastic*  
**C33**  **C32**  
  
*metal part*

*plastic C49*  
  
*metal part*

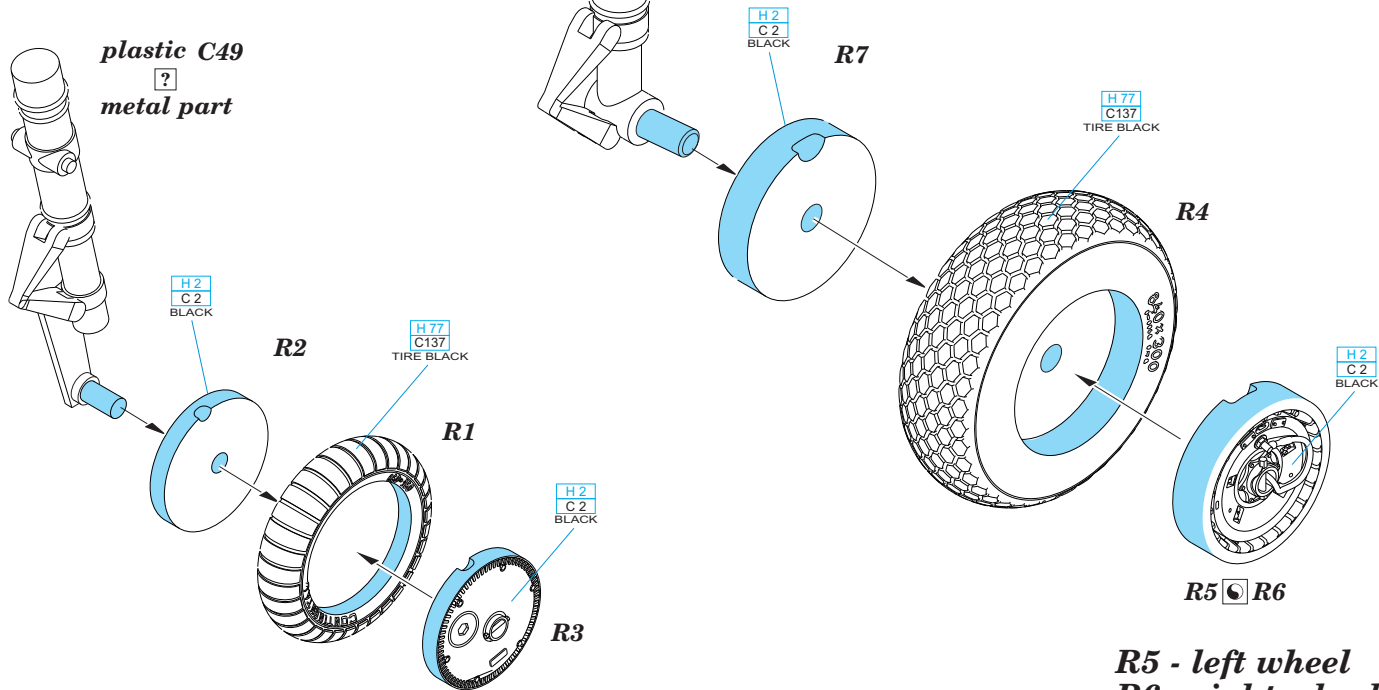

**R5 - left wheel**  
**R6 - right wheel**