

# 648 154 Bf 109G undercarriage legs BRONZE

For Eduard kit - pro stavebnici Eduard

**eduard**  
**BRASSIN**

1/48 scale

M1



M2



R80



R81



## COLOURS

GSI Creos (GUNZE)		Mr.METAL COLOR	
AQUEOUS	Mr.COLOR		
H 70	C 60	MC218	ALUMINIUM
	RLM02 GRAY		

This product contains metal and resin detail parts for upgrading scale plastic models. When selecting this set make sure that it is for the kit mentioned in product name as these sets are made specifically for that kit. When upgrading the model some cutting or corrections may be necessary for parts to fit accurately. **WARNING!** This set contains small and sharp parts. Work carefully in a ventilated and well-lit room. Safety glasses are recommended. This product is not suitable for children below 14 years of age.

Tento výrobek obsahuje leptané a odlévané detaily pro úpravu a vylepšení plastického modelu. Při výběru sady kovových detailů zkontrolujte, zda je určena pro model, který chcete upravit. Model, pro který je sada určena, je uveden u názvu výrobku. Pro přesnou aplikaci kovových a odlévaných dílů může být zapotřebí upravit díly upravovaného modelu. **POZOR!** Sada obsahuje malé ostré díly. Pracujte ve větrané a dobře osvětlené místnosti. Doporučujeme použití ochranných brýlí. Tento výrobek není vhodný pro děti mladší 14 let.

**eduard**

435 21 Obrnice 170  
Czech Republic



www.eduard.com



# 648 154 Bf 109G undercarriage legs BRONZE 1/48

For Eduard kit - pro stavebnici Eduard

**BRASSIN**











**BRASSIN**

**eduard**



**BEST BRASS RESIN AROUND!**

-  REMOVE  
ODSTRANIT
-  BEND  
OHNOUT
-  GRIND  
OBROUSIT
-  OPTION  
VOLBA
-  DRILL HOLE  
VRTAT OTVOR
-  REPLACE  
NAHRADIT
-  SYMMETRICAL ASSEMBLY  
SYMETRICKÁ MONTÁŽ
-  SCRIBE THE PANEL AND HOLES  
RYTÍ
-  REVERSE SIDE  
OTOČIT

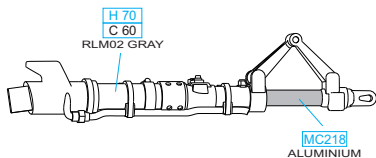

**BRASSIN**  
648 149  
648 158  
?  
*plastic parts*

H 70  
C 60  
RLM02 GRAY

**R80**

**M1**

**R81**

H 70  
C 60  
RLM02 GRAY

**M2**

**BRASSIN**  
648 149  
648 158  
?  
*plastic parts*

*plastic parts*

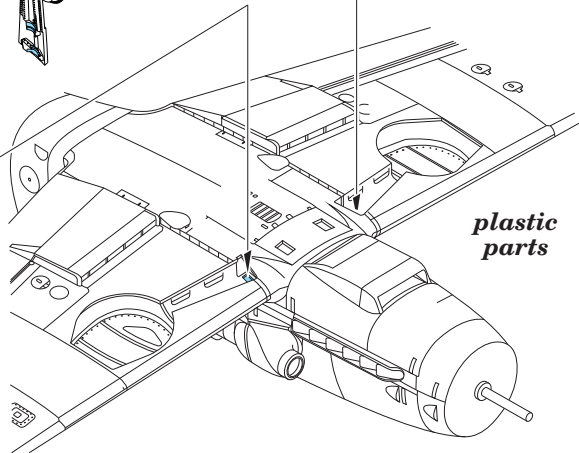

**FRONT VIEW**



**LEFT SIDE VIEW**

