

R6 8pcs.

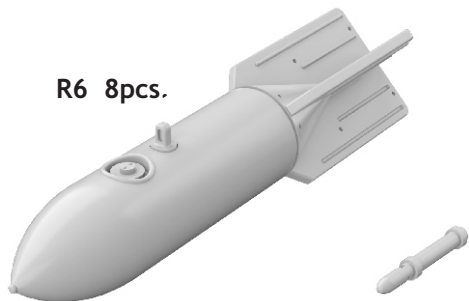

R7 32pcs.

1/48 scale

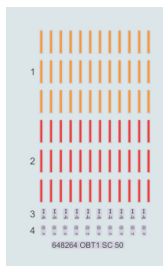

COLOURS

| GSI Creos (GUNZE) | | Mr.METAL COLOR | |
|-------------------|----------|------------------|-----------------------|
| AQUEOUS | Mr.COLOR | | |
| [H 64] | [C 17] | RLM71 DARK GREEN | [MC211] CHROME SILVER |
| | | | [MC219] BRASS MESSING |

This product contains metal and resin detail parts for upgrading scale plastic models. When selecting this set make sure that it is for the kit mentioned in product name as these sets are made specifically for that kit. When upgrading the model some cutting or corrections may be necessary for parts to fit accurately. **WARNING!** This set contains small and sharp parts. Work carefully in a ventilated and well-lit room. Safety glasses are recommended. This product is not suitable for children below 14 years of age.

Tento výrobek obsahuje leptané a odlévané detaily pro úpravu a vylepšení plastického modelu. Při výběru sady kovových detailů zkontrolujte, zda je určena pro model, který chcete upravit. Model, pro který je sada určena, je uveden u názvu výrobku. Pro přesnou aplikaci kovových a odlévaných dílů může být zapotřebí upravit díly upravovaného modelu. **POZOR!** Sada obsahuje malé ostré díly. Pracujte ve větrané a dobře osvětlené místnosti. Doporučujeme použití ochranných brýlí. Tento výrobek není vhodný pro děti mladší 14 let.

eduard

435 21 Obrnice 170
Czech Republic

www.eduard.com



BRASSIN

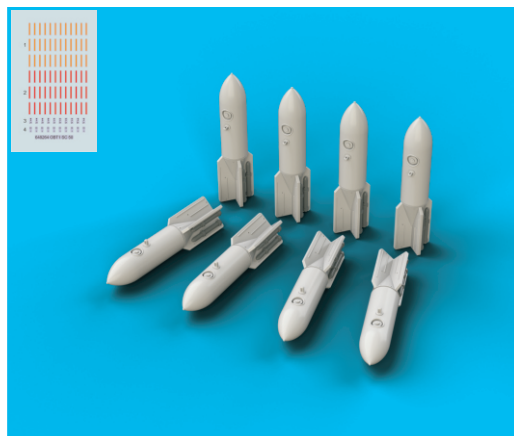







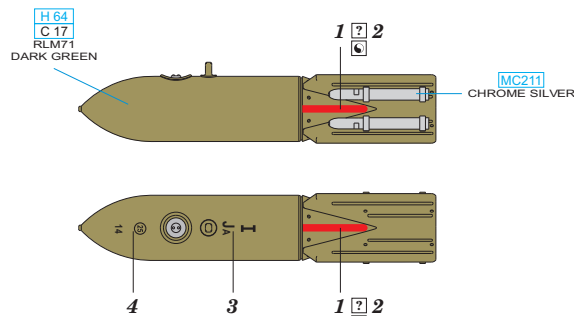

BRASSIN

eduard

SC 50 German WWII bombs



BEST BRASS RESIN AROUND!

- | | |
|---|---|
|  REMOVE ODSTRANIT |  BEND OHNOUT |
|  GRIND OBROUSIT |  OPTION VOLBA |
|  DRILL HOLE VRTAT OTVOR |  REPLACE NAHRADIT |
|  SYMMETRICAL ASSEMBLY SYMETRICKÁ MONTÁŽ | |
|  SCRIBE THE PANEL AND HOLES RYTÍ | |
|  REVERSE SIDE OTOČIT | |

8 pcs.

