

# 648 284 Harrier GR Mk.7/9

for Hasegawa kit - pro stavebnici Hasegawa

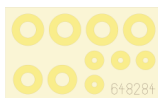

1/48 scale

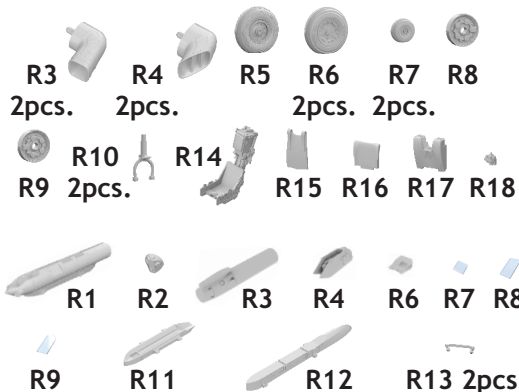

## COLOURS

GSI Creos (GUNZE)			GSI Creos (GUNZE)		
AQUEOUS	Mr.COLOR		AQUEOUS	Mr.COLOR	
[H 3]	[C 3]	RED	[H91]	[C48]	CLEAR YELLOW
[H 6]	[C 8]	SILVER	[H305]	[C305]	GRAY
[H12]	[C33]	FLAT BLACK	[H316]	[C316]	WHITE
[H76]	[C61]	BURNT IRON			
[H77]	[C137]	TIRE BLACK			
[H79]	[C39]	SANDY YELLOW			
[H80]	[C54]	KHAKI GREEN			
			Mr.METAL COLOR		

This product contains metal and resin detail parts for upgrading scale plastic models. When selecting this set make sure that it is for the kit mentioned in product name as these sets are made specifically for that kit. When upgrading the model some cutting or corrections may be necessary for parts to fit accurately. WARNING! This set contains small and sharp parts. Work carefully in a ventilated and well-lit room. Safety glasses are recommended. This product is not suitable for children below 14 years of age.

Tento výrobek obsahuje leptané a odlévané detaily pro úpravu a vylepšení plastického modelu. Při výběru sady kovových detailů zkontrolujte, zda je určena pro model, který chcete upravit. Model, pro který je sada určena, je uveden u názvu výrobku. Pro přesnou aplikaci kovových a odlévaných dílů může být zapotřebí upravit díly upravovaného modelu. POZOR! Sada obsahuje malé ostré díly. Pracujte ve větrané a dobře osvětlené místnosti. Doporučujeme použití ochranných brýlí. Tento výrobek není vhodný pro děti mladší 14 let.



www.eduard.com

435 21 Obrnice 170  
Czech Republic



# 648 284 Harrier GR Mk.7/9

for Hasegawa kit - pro stavebnici Hasegawa

1/48

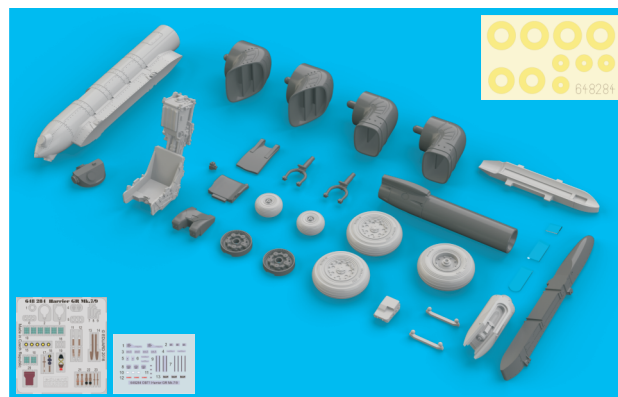
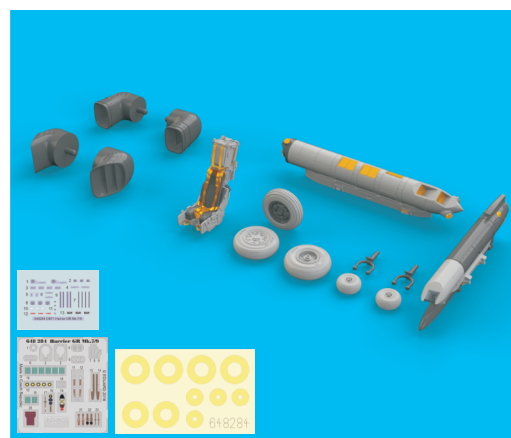

~~BEST BRASS~~ RESIN AROUND!

- |                           |                     |                                           |
|---------------------------|---------------------|-------------------------------------------|
| REMOVE<br>ODSTRANIT       | BEND<br>OHNOUT      | SYMMETRICAL ASSEMBLY<br>SYMETRICKÁ MONTÁŽ |
| GRIND<br>OBROUSIT         | OPTION<br>VOLBA     | SCRIBE THE PANEL AND HOLES<br>RYTI        |
| DRILL HOLE<br>VRTAT OTVOR | REPLACE<br>NAHRADIT | REVERSE SIDE<br>OTOČIT                    |

**1**

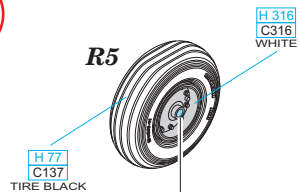

plastic  
X24

**3**

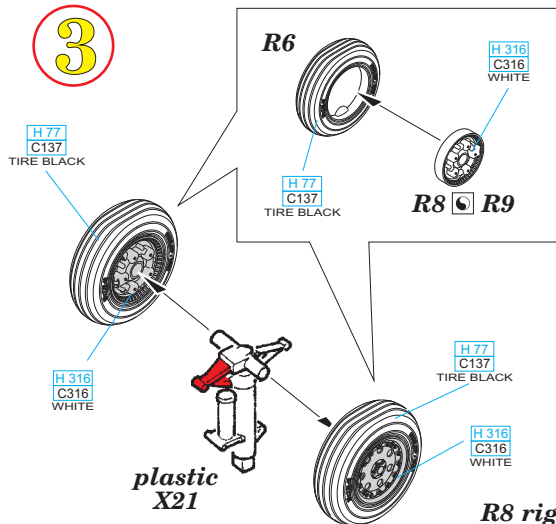

plastic  
X21

**2**

2 pcs.

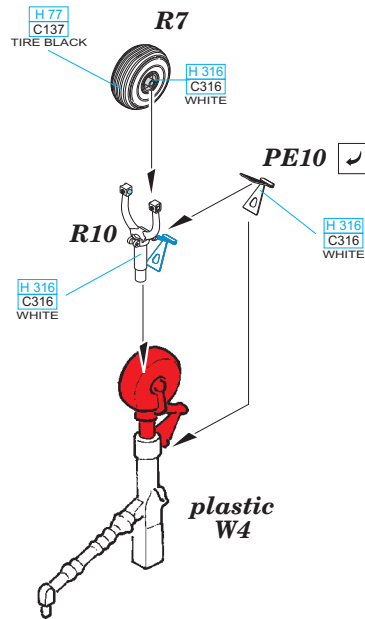

plastic  
W4

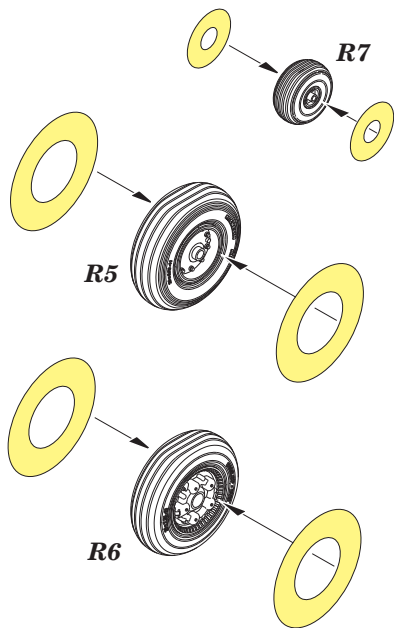
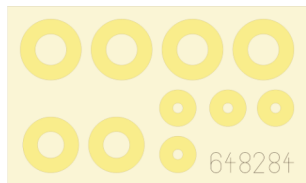

R8 right wheel  
R9 left wheel

