

648 381 Fw 190A exhaust stacks

for Eduard kit - pro stavebnici Eduard

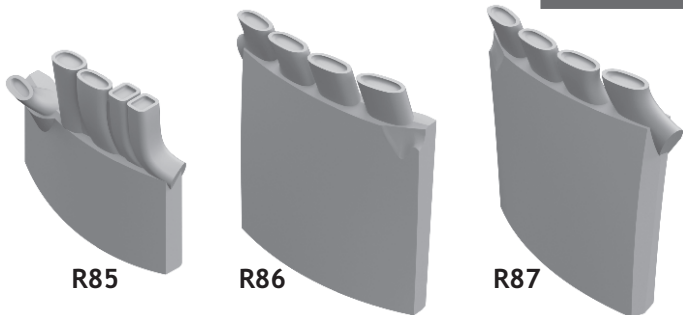

1/48 scale



R85

R86

R87

COLOURS

GSI Creos (GUNZE)			Mr.METAL COLOR	
AQUEOUS	Mr.COLOR		MC214	DARK IRON

This product contains metal and resin detail parts for upgrading scale plastic models. When selecting this set make sure that it is for the kit mentioned in product name as these sets are made specifically for that kit. When upgrading the model some cutting or corrections may be necessary for parts to fit accurately. **WARNING!** This set contains small and sharp parts. Work carefully in a ventilated and well-lit room. Safety glasses are recommended. This product is not suitable for children below 14 years of age.

Tento výrobek obsahuje leptané a odlévané detaily pro úpravu a vylepšení plastického modelu. Při výběru sady kovových detailů zkontrolujte, zda je určena pro model, který chcete upravit. Model, pro který je sada určena, je uveden u názvu výrobku. Pro přesnou aplikaci kovových a odlévaných dílů může být zapotřebí upravit díly upravovaného modelu. **POZOR!** Sada obsahuje malé ostré díly. Pracujte ve větrané a dobře osvětlené místnosti. Doporučujeme použití ochranných brýlí. Tento výrobek není vhodný pro děti mladší 14 let.

eduard

435 21 Obrnice 170
Czech Republic

www.eduard.com



648 381 Fw 190A exhaust stacks 1/48

for Eduard kit - pro stavebnici Eduard

BRASSIN

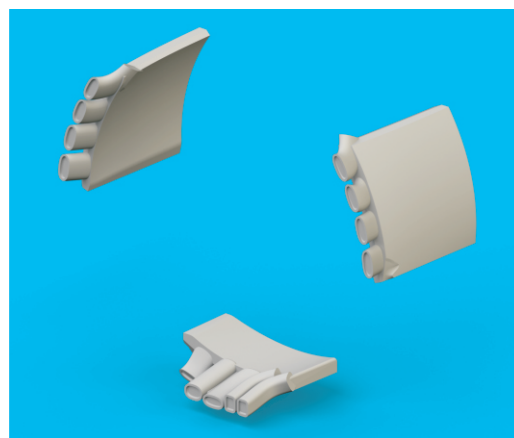

BRASSIN

eduard

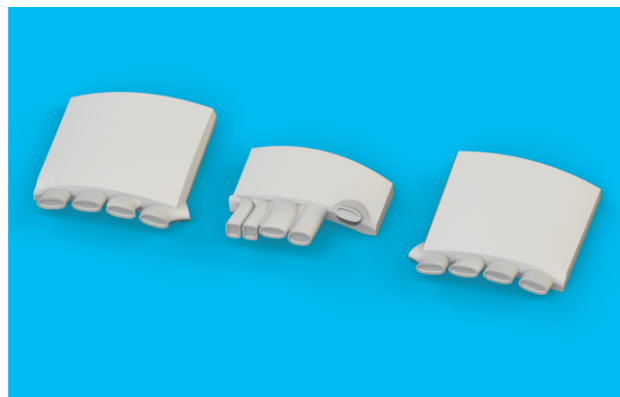

BEST BRASS RESIN AROUND!

1

plastic parts

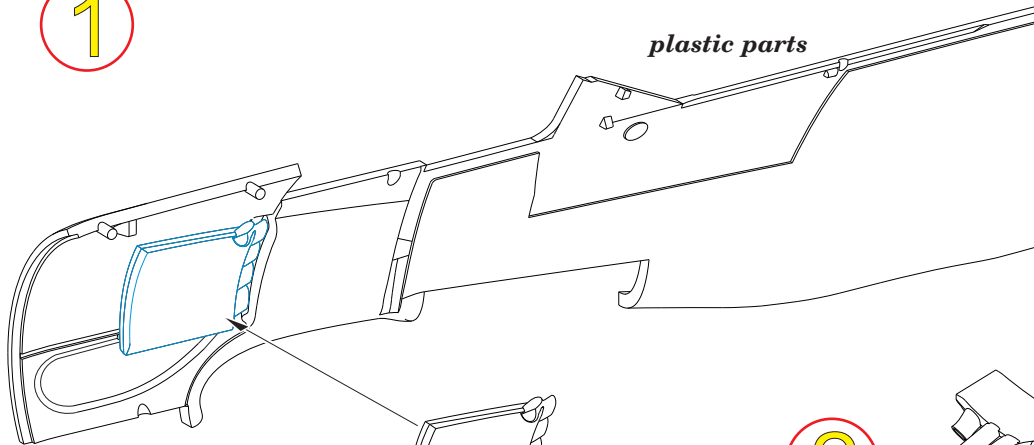

MC214
DARK IRON

R87
R86







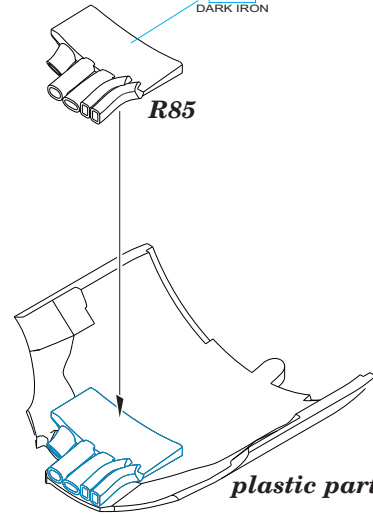

2

MC214
DARK IRON

R85



plastic part

-  REMOVE
ODSTRANIT
-  GRIND
OBROUSIT
-  DRILL HOLE
VRTAT OTVOR
-  SYMMETRICAL ASSEMBLY
SYMETRICKA MONTAZ
-  SCRIBE THE PANEL AND HOLES
RYTI
-  REVERSE SIDE
OTOČIT
-  BEND
OHNOUT
-  OPTION
VOLBA
-  REPLACE
NAHRADIT

