

648 531 P-51D 110gal fuel tank

for Eduard kit - pro stavebnici Eduard



1/48 scale



R105 2pcs.



R106 R107 R108 R109

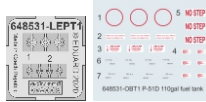

COLOURS

GSI Creos (GUNZE)			Mr.METAL COLOR	
AQUEOUS	Mr.COLOR			
[H3]	[C3]	RED	[SM201]	SUPER FINE SILVER
[H12]	[C33]	FLAT BLACK		
[H37]	[C43]	WOOD BROWN		

This product contains metal and resin detail parts for upgrading scale plastic models. When selecting this set make sure that it is for the kit mentioned in product name as these sets are made specifically for that kit. When upgrading the model some cutting or corrections may be necessary for parts to fit accurately. **WARNING!** This set contains small and sharp parts. Work carefully in a ventilated and well-lit room. Safety glasses are recommended. This product is not suitable for children below 14 years of age.

Tento výrobek obsahuje leptané a odlévané detaily pro úpravu a vylepšení plastického modelu. Při výběru sady kovových detailů zkontrolujte, zda je určena pro model, který chcete upravit. Model, pro který je sada určena, je uveden u názvu výrobku. Pro přesnou aplikaci kovových a odlévaných dílů může být zapotřebí upravit díly upravovaného modelu. **POZOR!** Sada obsahuje malé ostré díly. Pracujte ve větrané a dobře osvětlené místnosti. Doporučujeme použití ochranných brýlí. Tento výrobek není vhodný pro děti mladší 14 let.



www.eduard.com
14,95

435 21 Obrnice 170
Czech Republic



648 531 P-51D 110gal fuel tank 1/48

for Eduard kit - pro stavebnici Eduard

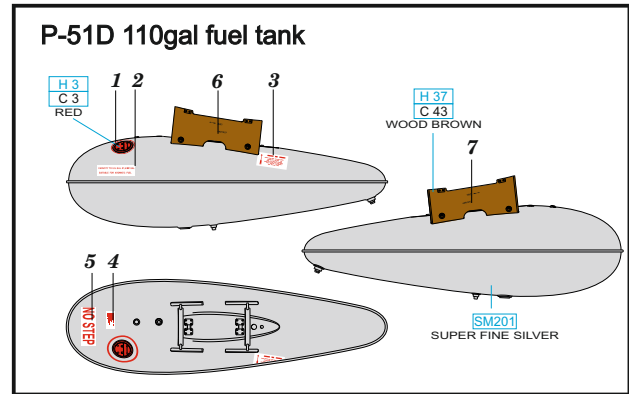
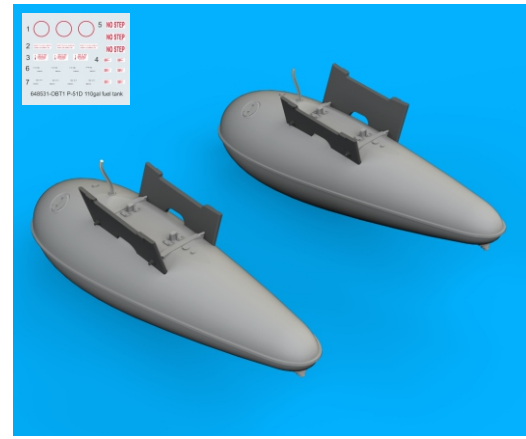

BEST BRASS RESIN AROUND!

1

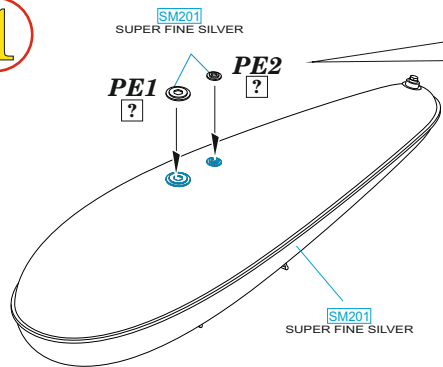

R105

2

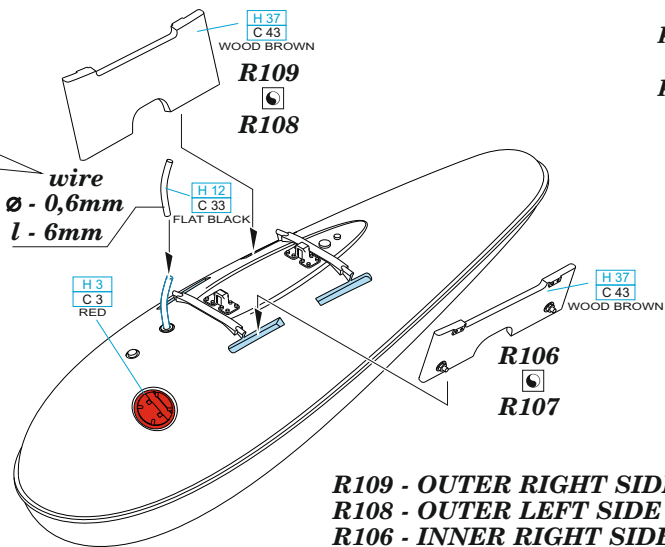
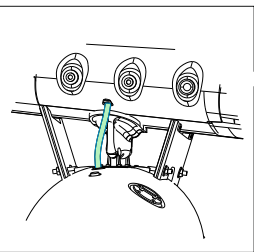

R109 - OUTER RIGHT SIDE
 R108 - OUTER LEFT SIDE
 R106 - INNER RIGHT SIDE
 R107 - INNER LEFT SIDE

3

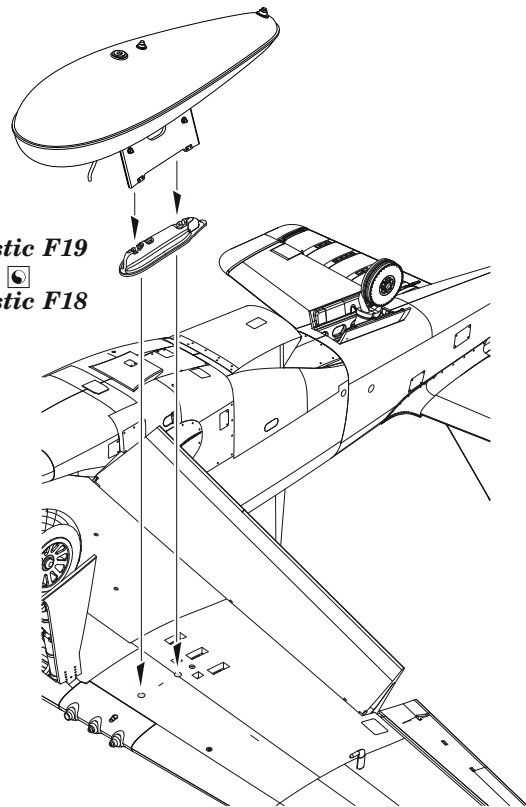

- REMOVE ODSTRANIT
- BEND OHNOUT
- SYMMETRICAL ASSEMBLY SYMETRICKÁ MONTÁŽ
- GRIND OBRUSIT
- OPTION VOLBA
- SCRIBE THE PANEL AND HOLES RYTI
- DRILL HOLE VRTAT OTVOR
- REPLACE NAHRADIT
- REVERSE SIDE OTOČIT