

**648 604 Bf 110G-4 gun muzzles**  
for Eduard kit - pro stavebnici Eduard

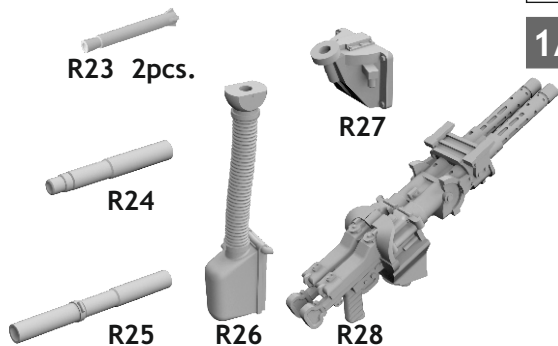

**1/48 scale**



**COLOURS**

GSI Creos (GUNZE)			Mr. METAL COLOR	
AQUEOUS	Mr. COLOR			
<a href="#">H 12</a>	<a href="#">C 33</a>	FLAT BLACK	<a href="#">MC214</a>	DARK IRON

**648 604 Bf 110G-4 gun muzzles**  
for Eduard kit - pro stavebnici Eduard

**1/48**

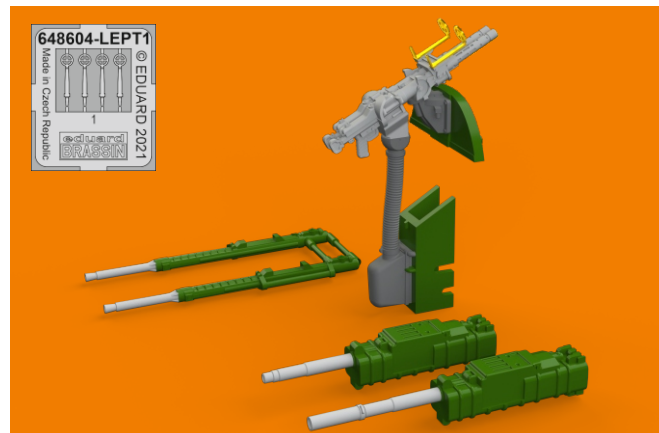

**eduard**

**eduard**  
435 21 Obrnice 170  
Czech Republic

[www.eduard.com](http://www.eduard.com)  
9,95



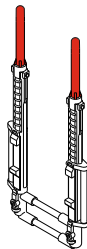

plastic T23

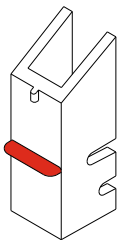

plastic S40



plastic T16

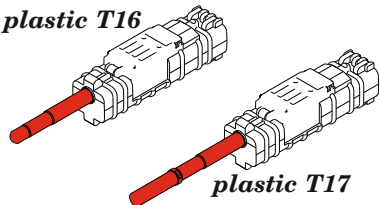

plastic T17

3

plastic T16



R24

MC214  
DARK IRON

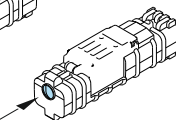
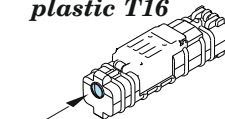

plastic T17

R25

1

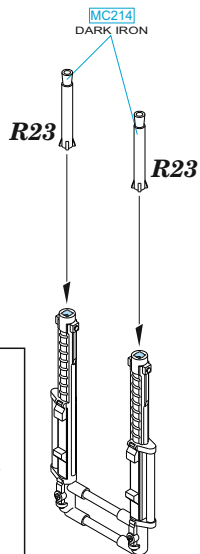

plastic T23

2

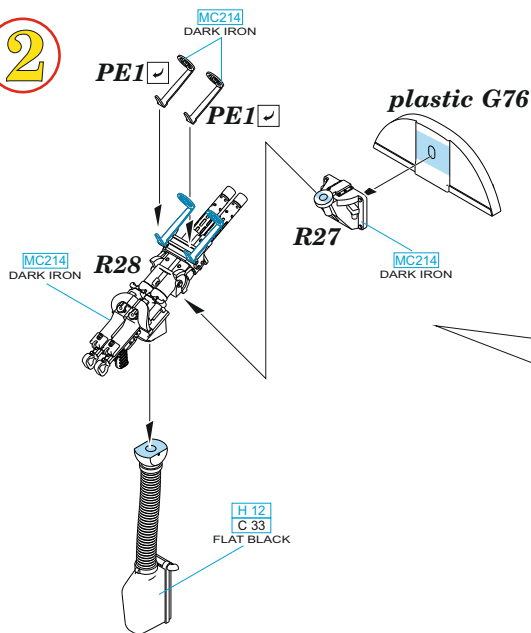

plastic G76

R27









MC214  
DARK IRON

R28

H 12  
C 33  
FLAT BLACK

R26

plastic S40

-  REMOVE  
ODSTRANIT
-  GRIND  
OBROUSIT
-  DRILL HOLE  
VRTAT OTVOR
-  SYMMETRICAL ASSEMBLY  
SYMETRICKA MONTAZ
-  SCRIBE THE PANEL AND HOLES  
RYTI
-  REVERSE SIDE  
OTOČIT
-  BEND  
OHNOUT
-  OPTION  
VOLBA
-  REPLACE  
NAHRADIT