

648 615 AGM-62 Walleye I ER/ERDL

eduard
BRASSIN

1/48 scale

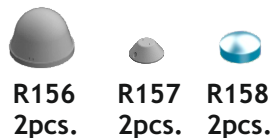

R156 2pcs.
R157 2pcs.
R158 2pcs.

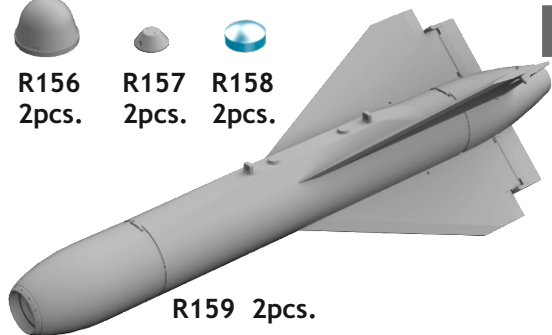

R159 2pcs.

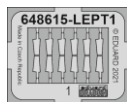

COLOURS

GSI Creos (GUNZE)			Mr.METAL COLOR
AQUEOUS	Mr.COLOR		
[H 3]	[C 3]	RED	
[H 18]	[C 28]	STEEL	
[H316]	[C316]	WHITE	

This product contains metal and resin detail parts for upgrading scale plastic models. When selecting this set make sure that it is for the kit mentioned in product name as these sets are made specifically for that kit. When upgrading the model some cutting or corrections may be necessary for parts to fit accurately. **WARNING!** This set contains small and sharp parts. Work carefully in a ventilated and well-lit room. Safety glasses are recommended. This product is not suitable for children below 14 years of age.

Tento výrobek obsahuje leptané a odlévané detaily pro úpravu a vylepšení plastického modelu. Při výběru sady kovových detailů zkontrolujte, zda je určena pro model, který chcete upravit. Model, pro který je sada určena, je uveden u názvu výrobku. Pro přesnou aplikaci kovových a odlévaných dílů může být zapotřebí upravit díly upravovaného modelu. **POZOR!** Sada obsahuje malé ostré díly. Pracujte ve větrané a dobře osvětlené místnosti. Doporučujeme použití ochranných brýlí. Tento výrobek není vhodný pro děti mladší 14 let.

eduard

435 21 Obrnice 170
Czech Republic

www.eduard.com
12,95



648 615 AGM-62 Walleye I ER/ERDL

1/48

BRASSIN

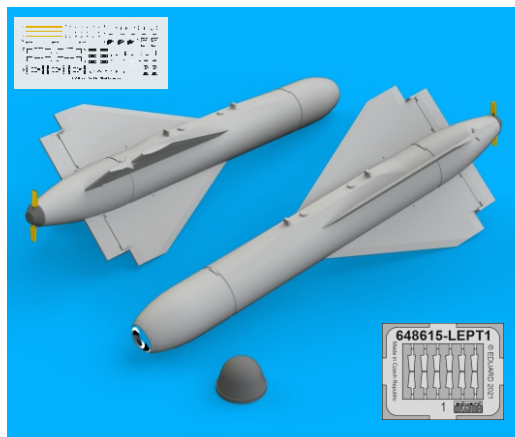

BRASSIN

eduard

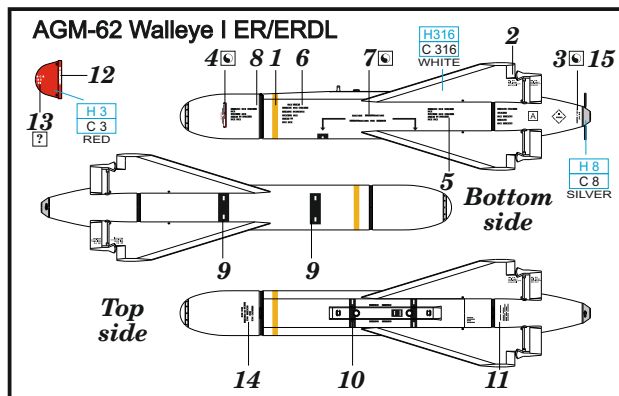

BEST BRASS RESIN AROUND!

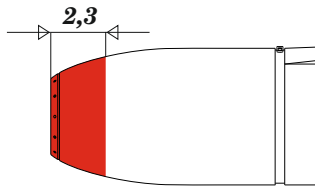

H3
C3
RED

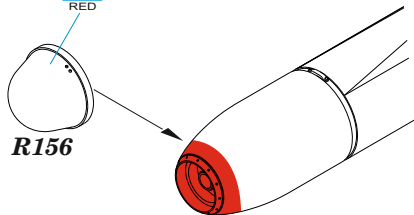

R156

R158  R156

R158

H316
C316
WHITE

R159

PE01











R157

H18
C28
STEEL

PE01



- | | | | |
|---|---|---|---------------------|
|  | REMOVE
ODSTRANIT |  | BEND
OHNOUT |
|  | GRIND
OBROUSIT |  | OPTION
VOLBA |
|  | DRILL HOLE
VRTAT OTVOR |  | REPLACE
NAHRADIT |
|  | SYMMETRICAL ASSEMBLY
SYMETRICKÁ MONTÁŽ | | |
|  | SCRIBE THE PANEL AND HOLES
RYTI | | |
|  | REVERSE SIDE
OTOČIT | | |