

**672 370 P-51D wheels
diamond tread 2**
for Eduard kit - pro stavebnici Eduard



1/72 scale



R5



R10 2pcs.

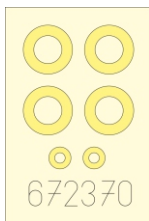

COLOURS

GSI Creos (GUNZE)		Mr.METAL COLOR	
AQUEOUS	Mr.COLOR		
[H 8]	[C 8]	SILVER	
[H 77]	[C137]	TIRE BLACK	

672 370

**P-51D wheels
diamond tread 2**
for Eduard kit - pro stavebnici Eduard

1/72



eduard

eduard

**435 21 Obrnice 170
Czech Republic**

**www.eduard.com
7,95**



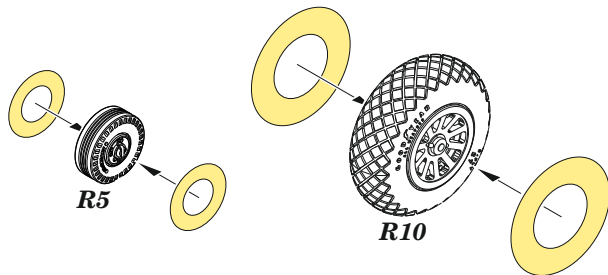
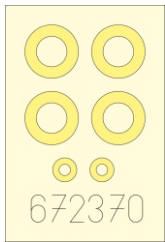

1



2

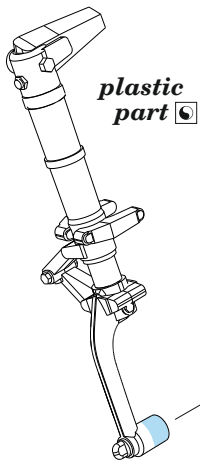
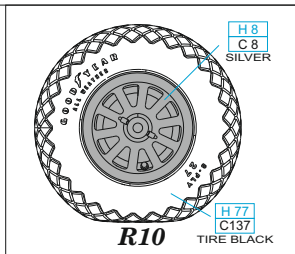

3

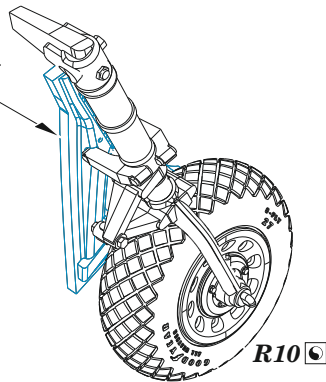
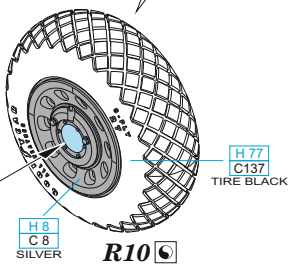
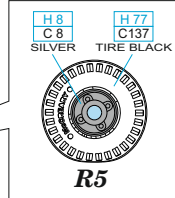
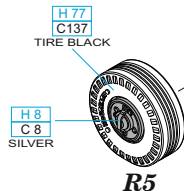
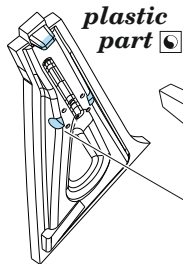

- | | |
|---|----------------------|
| REMOVE
ODSTRANIT | BEND
OHNOUT |
| GRIND
OBROUSIT | ?
OPTION
VOLBA |
| DRILL HOLE
VRTAT OTVOR | REPLACE
NAHRADIT |
| SYMMETRICAL ASSEMBLY
SYMETRICKA MONTAZ | |
| SCRIBE THE PANEL AND HOLES
RYTI | |
| REVERSE SIDE
OTO CIT | |